

PRECASTER

ACN 051 987 181 • ISSN 1037-9908

Thermal performance of precast: *what you need to know*

The inclusion of energy efficiency measures for buildings in the Building Code of Australia as Section J, is part of a broader strategy being undertaken by State, Territory and Federal governments to reduce greenhouse gas emissions.

Energy efficiency measures for housing were introduced into the BCA in 2003 and have since been extended to cover all classifications of buildings in all Climate Zones (refer to Climate Zone Map and Building Classifications below).

Section J in Volume 1 of the BCA covers all Class 2 to 9 buildings in all climate zones, and Part J1 Building Fabric, addresses the energy efficiency performance of various building elements. Each element within Part J1 is intended to work as part of a system to achieve overall building energy efficiency. To comply with the BCA, the building must either:

- use one of the **'Deemed-to-Satisfy' (DTS)** provisions included in Section J. As with the holistic nature of all other aspects of the BCA, each DTS provision is designed to work as part of a system, to ensure the building achieves the desired level of energy efficiency.
- or** (if there is a state change in one part or if the DTS provisions are too restrictive)
- use a **'Verification Method'** to determine compliance of an **'Alternative Solution'** (and ensure there are no unintended effects on the other parts as a consequence). These 'Alternative Solutions' are outside the prescriptive DTS provisions, and assessments based on a Verification Method are usually undertaken by an experienced energy assessor using software which complies with relevant ABCB protocol.

It is important to note that the energy measures generally apply to buildings being refurbished, altered or extended as well as new buildings, depending on the building law in the particular jurisdiction.

BCA 2007 Climate Zone Map



Building Classifications

(note: For full classifications list refer to Australian Building Codes Board, BCA, Volume One, Classification of Buildings and Structures, pages 39-41 of BCA 2007)

- Class 1a:** Single dwelling houses including detached and attached dwellings.
- Class 1b:** Boarding houses, guest houses, hostels etc. with floor area less than 300 m² and less than 12 residents.
- Class 2:** A building with two or more sole-occupancy units that are separate dwellings.
- Class 3:** Boarding houses, guest houses, hostels, lodging-houses or back packers accommodation. Residential parts of hotels, motels, schools, health-care buildings or detention centres. Accommodation buildings for the aged, children or disabled.
- Class 4:** A dwelling part of a Class 5, 6, 7, 8 or 9 building.
- Class 5:** Office buildings.
- Class 6:** Shops or other buildings for the sale of goods, eg restaurants, barber's shops, laundries, markets, showrooms and service stations.
- Class 7a:** Car parks.
- Class 7b:** Storage or display of goods.
- Class 8:** Laboratories, production areas.
- Class 9a:** Health-care buildings.
- Class 9b:** Assembly buildings, trade workshops, laboratories in schools.
- Class 9c:** Aged care buildings.
- Class 10a:** Non-habitable garages, carports and sheds.



Precast Seminars at Form & Function
10-12 April 2008 – Sydney Convention & Exhibition Centre

- Shape Colour & Texture
- Building with Precast: A Panel of Professionals
- Section J & Precast Concrete

Refer the Form & Function website for locations and times www.formandfunctionexpo.com.au/seminars.htm

Requirements for Walling

Many architects, builders and developers simply haven't had the time to catch up with the implications of Section J, particularly in reference to the performance requirements for walls.

The easiest way to comply with Section J is by using one of the Part J1 DTS provisions.

The following tables have been reproduced from the Building Code of Australia:

| Table J1.5a Deemed to Satisfy Options for External Walling, Multi-Residential | |
|---|--|
| Climate Zone | Options |
| 1, 2 & 3 | (a) Achieve a minimum Total R-Value of 1.4, or (b) Shade the external wall of the storey with a verandah, balcony, eaves, overhang, carport or the like which projects at a minimum angle of 15 degrees in accordance with Figure J1.5 (refer BCA). |
| 4 | (a) Achieve a minimum Total R-Value of 1.7, or (b) Achieve a surface density of not less than 220 kg/m ² |
| 5 | (a) Achieve a minimum Total R-Value of 1.4, or (b) Achieve a surface density of not less than 220 kg/m ² |
| 6 | (a) Achieve a minimum Total R-Value of 1.7, or (b) (i) Achieve a surface density of not less than 220 kg/m ² ; and (ii) the storey to be constructed on a flooring system that is in direct contact with the ground, such as a concrete slab-on-ground or the like, or (c) (i) Achieve a surface density of not less than 220 kg/m ² ; and (ii) incorporate insulation with an R-Value of not less than 1.0. |
| 7 | (a) Achieve a minimum Total R-Value of 1.9, or (b) (i) Achieve a surface density of not less than 220 kg/m ² ; and (ii) incorporate insulation with an R-Value of not less than 1.0. |
| 8 | Achieve a minimum Total R-Value of 2.8. |

Steps to comply

1. Identify your climate zone.
2. Identify your building classification.
3. Choose the best DTS solution for your situation.
4. Choose the best precast solution for your situation (see page 6).



Table J1.5b Deemed to Satisfy Options for External Walling, Commercial

| Climate Zone | Options |
|--------------|--|
| 1, 3, 4 & 6 | (a) Achieve a minimum Total R-Value of 1.8, or (b) (i) Achieve a surface density of not less than 220 kg/m ² ; and (ii) incorporate a cavity of 20 mm to 35 mm; and (iii) shade the external wall of the storey with a verandah, balcony, eaves, overhang, covered carpark, carport or the like which projects at a minimum angle of 15 degrees in accordance with Figure J1.5 (refer BCA); and (iv) incorporate insulation with an R-Value of not less than 1.0, or (c) (i) Achieve a surface density of not less than 220 kg/m ² with masonry that has a thermal conductivity of less than 0.8; and (ii) incorporate a cavity of 20 mm to 35 mm; and (iii) incorporate insulation with an R-Value of not less than 1.0, or (d) (i) Achieve a surface density of not less than 220 kg/m ² with masonry that has a thermal conductivity of less than 0.8; and (ii) shade the external wall of the storey with a verandah, balcony, eaves, overhang, covered carpark, carport or the like which projects at a minimum angle of 30 degrees in accordance with Figure J1.5 (refer BCA); and (iii) incorporate insulation with an R-Value of not less than 0.5, or (e) For an external wall where the only space for insulation is provided by a furring channel, top hat section, batten or the like (i) achieve a minimum Total R-Value of 1.4; and (ii) satisfy glazing energy index option B of Table J2.4a (refer BCA). |
| 2 and 5 | (a) Achieve a minimum Total R-Value of 1.8, or (b) (i) Achieve a surface density of not less than 220 kg/m ² with masonry that has a thermal conductivity of less than 0.8; and (ii) shade the external wall of the storey with a verandah, balcony, eaves, overhang, covered carpark, carport or the like which projects at a minimum angle of 30 degrees in accordance with Figure J1.5 (refer BCA). (c) (i) Achieve a surface density of not less than 220 kg/m ² ; and (ii) incorporate a cavity of 20 mm to 35 mm; and (iii) shade the external wall of the storey with a verandah, balcony, eaves, overhang, covered carpark, carport or the like which projects at a minimum angle of 15 degrees in accordance with Figure J1.5 (refer BCA); and (iv) incorporate insulation with an R-value of not less than 0.5, or (d) (i) Achieve a surface density of not less than 220 kg/m ² with masonry that has a thermal conductivity of less than 0.8; and (ii) incorporate a cavity of 20 mm to 35 mm; and (iii) incorporate insulation with an R-Value of not less than 0.5, or (e) For an external wall where the only space for insulation is provided by furring channel, top hat section, batten or the like (i) achieve a minimum Total R-Value of 1.4; and (ii) satisfy glazing energy index option B of Table J2.4a (refer BCA). |
| 7 | (a) Achieve a minimum Total R-Value of 1.8, or (b) (i) Achieve a surface density of not less than 220 kg/m ² ; and (ii) incorporate a cavity of 20 mm to 35 mm; and (iii) shade the external wall of the storey with a verandah, balcony, eaves, overhang, covered carpark, carport or the like which projects at a minimum angle of 15 degrees in accordance with Figure J1.5 (refer BCA); and (iv) incorporate insulation with an R-value of not less than 1.0, or (c) (i) Achieve a surface density of not less than 220 kg/m ² with masonry that has a thermal conductivity of less than 0.8; and (ii) incorporate a cavity of 20 mm to 35 mm; and (iii) incorporate insulation with an R-value of not less than 1.0, or (d) For an external wall where the only space for insulation is provided by a furring channel, top hat section, batten or the like (i) achieve a minimum Total R-Value of 1.4; and (ii) satisfy glazing energy index option B of Table J2.4a (refer BCA). |
| 8 | Achieve a minimum Total R-Value of 2.8. |

Note that some of the options in Table J1.5(a) and (b) permit a wall with a surface density of at least 220 kg/m² to not require any, or as much, additional insulation. Surface density is the weight of one vertical square metre of the wall construction, and 140 mm or thicker solid concrete walls usually achieve the 220 kg/m²

Requirements for Flooring

Suspended floors above spaces with an unenclosed perimeter are required under Part J1 to achieve the total R-value specified in Table J1.6 where they are between a conditioned and a non-conditioned space. An example is the floor between an office and an open carpark or open storage area. Precast flooring is increasingly selected for its economy and versatility, with the application of insulation where required, as shown in the typical solutions on page 6. A slab that forms part of a roof or ceiling must comply with the insulation requirements of Table J1.3 (refer BCA).

The following table has been reproduced from the Building Code of Australia:

| Table J1.6 Deemed to Satisfy Options for Suspended Flooring With Unenclosed Perimeter | | | | | | | | | |
|---|--------------|---------------------|---------------------------|-----|-----|-----------|-----|-----|-----|
| Class of building | Climate zone | | | | | | | | |
| | 1 | 2 | | 3 | 4 | 5 | 6 | 7 | 8 |
| | | Below 300m altitude | At or above 300m altitude | | | | | | |
| 2, 3, 4 and 9c aged care building | Nil | Nil | Nil | Nil | Nil | Nil | 1.0 | 1.0 | 2.5 |
| 5, 6, 7, 8, 9a and 9b | 1.5 | Nil | Nil | 1.5 | 1.5 | Nil | 1.5 | | 2.5 |
| Direction of heat flow | Upwards | | Downwards and Upwards | | | Downwards | | | |

Note: Altitude means the height, above the Australian Height Datum, of the location where the building is to be constructed.

Precast – the easy way to comply with DTS provisions

Example: Precast wall panels plus insulation

According to Melbourne Architect Chris Viola, the benefits of using precast from a thermal perspective is that it's inherent thermal mass offers a unique energy-saving advantage. Using 175mm precast panels for the walls and 200 hollow core spanning 9 metres for the floors and roof, enable the absorption, storage, and later release of significant amounts of heat.

"Precast was the number one choice for this house because it absorbs energy slowly and holds it for much longer periods of time" says Viola. "In addition to this, the building uses less energy than a similar 'low mass' building because the heat transfer is reduced through the precast wall elements. And then there is the added benefit that many of the external concrete walls reveal themselves internally, allowing for good contact between the building surface and the internal air to maximise the heat transfer."

Exposed concrete inside the house maximises the thermal benefits of precast.

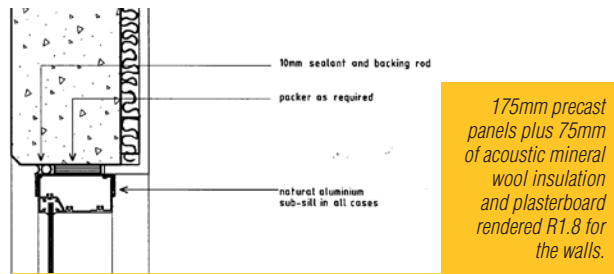

As Director of Melbourne based Westkon Precast, the owner Lorenzo Cremasco says that precast was the obvious choice for his house. "Not only did it make sense because I am in the business, but there were some pretty real benefits of using precast." Cremasco cites these as follows:

"The benefits of prefabrication are huge. We spent less time on site building, the quality of the finish is excellent, and there was no need for external scaffolding.

"Structurally we were able to have large open spaces and all internal walls are non load bearing so they could be moved or altered to suit our needs. We had to add an additional bedroom and adjust other rooms to suit, half way through construction, due to new additions to our family.

"The great thermal mass and acoustic properties of precast made sense as we have a freeway nearby. Combined with double glazing and northern orientation, maintaining constant temperatures inside has been easy, with the requirement of only turning on the heating for a short period during the day when the sun goes down."

Example: Precast sandwich wall panels & hollowcore



Thermohouse

Extensive use of precast, in the form of precast sandwich panel walling and hollowcore floors and roof provide all the benefits of thermal mass, while creating a stable internal environment.

Mikael Carlstrom's Thermohouse is a model of energy-efficient residential construction. Architect Chris de Campo, of Melbourne-based de Campo Architects, teamed with Westkon Precast to produce a home which is a showcase for sustainable living.

"Being my own home, it was an opportunity to fully put the sandwich panel system to the test," Carlstrom says. "So successful has been the result that in the first year since completion, the ambient temperature inside the house has fluctuated by only about five degrees. In summer, we open it up for a few hours in the morning to allow cooling air to enter from outside, and at night we again open it to purge the air. In winter, in-slab electric heating coupled with radiant heating in the

living areas helps to raise and maintain the temperature at a stable level. The reduction in our energy bills has been considerable."

According to architect de Campo, the walling system typically provides a performance R-value of R 4.2, significantly minimising internal temperature fluctuations. Fluctuations are reduced to 3.5 degrees in summer without the use of air-conditioning and to 4.5 degrees in winter using offpeak overhead radiant panels, which significantly reduce the running costs and optimise comfort levels.

Suspended hollowcore floors and roof (with ballasted roof insulation) give a performance level of R5.5. The building has an equivalent First Rate performance of 8 stars.

Head Detail Sandwich Panel

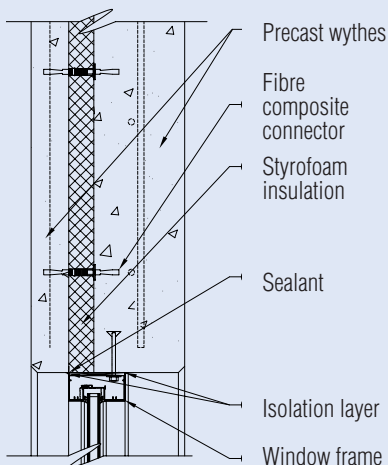

Quick find

- Climate Zone Map**
refer <http://www.abcb.gov.au/go/whatweredoing/workprogram/projectsae/energy/eemaps>
- BCA Energy Efficiency FAQ, Software Protocols, Information Seminar Powerpoint Presentations**
refer <http://www.abcb.gov.au/go/whatweredoing/workprogram/projectsae/energy>
- Building Classifications list**
refer Australian Building Codes Board, BCA, Volume One, Classification of Buildings and Structures, pages 39-41 of BCA 2007
- Tables J1.5a and J1.5b (covering residential and commercial walling)**
refer Australian Building Codes Board, BCA, Volume One, Classification of Buildings and Structures, pages 444-447 of BCA 2007
- Table J1.6 (covering residential and commercial suspended flooring)**
refer Australian Building Codes Board, BCA, Volume One, Classification of Buildings and Structures, pages 450 of BCA 2007

Example: Precast wall panels plus insulation

With a combination of acid etched and polished precast concrete walls, 299 Sussex Street Sydney is an 8 storey strata office building with ground floor shops and basement parking (BCA classes 5, 6 and 7a). The building has been rated by an independent energy assessor at 4.5 stars.

According to Bianco Precast General Manager Dino Pietrobon, precast was chosen for a number of reasons. "The construction team decided that precast offered the most practical solution as it overcame the difficulties of building over a boundary on a constrained site. It also allowed different surface finishes to be used on different elevations. For example, on the Southern elevation, we manufactured acid-etched dark coloured wall panels, to match the remaining 100 year old brick Samuel Hordern building. On the Northern and Western elevations, we produced polished off-white wall panels, which would assist with the heat loads in the building," says Pietrobon.

Off-white panels on the Northern and Western elevations assist with heat loads in the building.

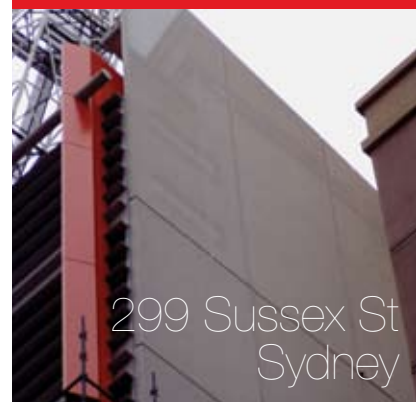

External Wall System 299 Sussex St Sydney

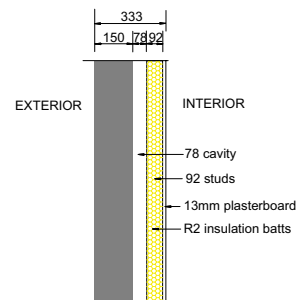

| Wall Element | Thickness (mm) | R |
|--------------------------|----------------|-------------|
| Inside surface-air film | | 0.12 |
| Plasterboard | 13 | 0.06 |
| Steel studs | 92 | |
| Insulation | 95 | 2.00 |
| Airspace | 20-80 | 0.17 |
| Precast panel | 150 | 0.10 |
| Outside surface-air film | | 0.08 |
| | | 2.18 |

Example: Ultrafloor plus insulation



Centrelink

Aluminium foil faced Styroboard sheets combined with precast flooring allows greater R values to be obtained in open and confined spaces.

The huge new Centrelink National Support Office in Tuggeranong ACT, relies on underslab insulation to prevent energy losses from conditioned office floors to non-conditioned floors such as stores and mechanical spaces. GSA Group Architects, working with Multiplex Constructions on the new offices, found that teaming up with Ultrafloor (Aust) Pty. Ltd. delivered the rewards of a fast track and largely problem-free insulated precast flooring construction system.

To insulate the underside of the Ultrafloor beams where required, the team selected StyReflex aluminium foil faced polystyrene sheets manufactured by Foamex Polystyrene Pty Ltd.

According to Ultrafloor General Manager Alan Morrison, "Matching the pedigree of

its precast flooring and insulation solution, the new Centrelink building will achieve a 4.5-star Australian Building Greenhouse Rating. The building incorporates leading-edge ecologically sustainable development innovations in areas such as energy consumption, greenhouse gas emissions, stormwater and grey water containment, and minimisation of water consumption and waste."

Chilled beam air conditioning will provide substantial energy savings. To help reduce water consumption levels, the site will have tanks for half a million litres of rainwater for use within the building. Hot water for the building will largely come from renewable resources, such as solar panels and/or wind generators on the roof. Fit-out is planned to be completed by November 2007.

Precast benefits for Energy Efficiency

More than half of the true total costs incurred during the economic life of a building may be attributable to operating and energy costs.

Precast concrete panels can be designed to provide a high degree of energy efficiency, providing an economic initial investment with a continuing payback.

Recessed window walls, vertical fins, sun hoods and various other sculptured shapes can facilitate the design of many types of shading devices for window areas to reduce glare and solar gain. These provide economies in the cost of the air-conditioning system by reducing thermal loads.

Specific wall thermal characteristics can be designed for each face of the structure to suit its sun orientation. To obtain a range of R-values, precast concrete walls may have insulation applied to the back, or the insulation may be incorporated into a sandwich wall panel to reduce heating and cooling costs. The thermal mass of concrete also saves energy year-round by reducing daily temperature swings.

BCA & Conditioned Spaces

Section J requirements are based on the likelihood of non-residential buildings being air-conditioned, with a higher energy use than in a residential building. Exemptions are given where the air conditioned area is for only a part of the space, such as at a check-out counter, is not likely. The intent is to ensure that the construction (walls, floors, and roofs) around the conditioned spaces has sufficient levels of thermal performance to significantly reduce the amount of energy used for conditioning. The BCA text of Clauses J1.2, J1.5 and J1.6, contains details of how insulation is to be installed, and requirements for internal walls that separate a conditioned space from a non-conditioned space.

News

National Precast Member **Hollow Core Concrete** has recently picked up two coveted industry awards. Master Builders Association (Victoria) has awarded the precaster the **Specialist Contractor of the Year Award**, for the Core Centre at Torquay. The full precast solution offered, afforded structure cost savings of 10 percent, and a six week time saving. Hollow Core was also awarded the **Award for Excellence** in the Engineering Projects Category, for the Lorne Pier Reconstruction at the recent Concrete Institute of Australia 2005 – 2007 Awards Presentation Dinner.

In the same Concrete Institute Awards, fellow National Precast Member **SA Precast** was awarded the **Award for Excellence** in the Building Projects Category, for the National Emergency Services Memorial.

Typical Precast Walling & Flooring Solutions

Precast Solid Wall Panel Thermal Resistance

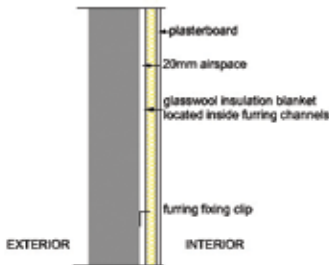

| Wall Element | Thickness (mm) | R |
|--|----------------|--------------|
| Outside surface-air-film (7m/s) | | 0.030 |
| Precast panel | 175 | 0.123 |
| 20mm airspace | 20 | 0.170 |
| 14Kg/m ³ glasswool insulation | 50 | 1.300 |
| Plasterboard | 13 | 0.076 |
| Inside surface-air-film | | 0.120 |
| | | 1.819 |

Note: use of steel furring channels may reduce the R-value of the insulation by up to 30 percent.

Precast Sandwich Wall Panel Thermal Resistance

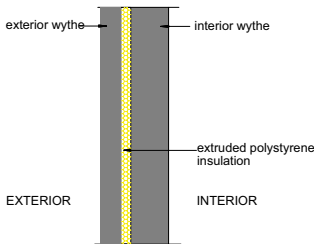

| Wall Element | Thickness (mm) | R |
|---------------------------------|----------------|--------------|
| Outside surface-air-film (7m/s) | | 0.030 |
| Exterior concrete panel | 75 | 0.052 |
| Extruded polystyrene | 60 | 1.850 |
| Interior concrete panel | 150 | 0.104 |
| Inside surface-air-film | | 0.120 |
| | | 2.156 |

Typical Hollowcore Floor Assembly Thermal Resistance

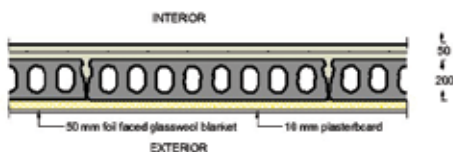

200mm Hollowcore Floor Slab
Conditioned internal space over external Space

| Floor Element | Thickness (mm) | R |
|--|----------------|--------------|
| Indoor surface-air-film | | 0.160 |
| Concrete topping | 50 | 0.033 |
| Hollowcore slab | 200 | 0.250 |
| 14Kg/m ³ glasswool insulation | 50 | 1.300 |
| Plasterboard | 10 | 0.060 |
| Outside subfloor air-film (7m/s) | | 0.030 |
| | | 1.833 |

Typical 'Ultrafloor' Floor Assembly Thermal Resistance

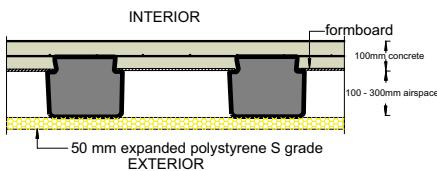

Ultrafloor Slab
Conditioned internal space over external Space

| Floor Element | Thickness (mm) | R |
|---------------------------------------|----------------|--------------|
| Indoor surface-air-film (still, down) | | 0.160 |
| Concrete slab | 100 | 0.069 |
| Formboard | 16 | 0.120 |
| Airspace (down, non-reflective) | 100-300 | 0.220 |
| Expanded polystyrene S grade | 50 | 1.240 |
| Outside subfloor air-film (7m/s) | | 0.030 |
| | | 1.839 |

Note: When using any insulation product National Precast strongly recommends that you verify:

- actual R-values of the insulation product with the insulation supplier, and
- the R-values of the total system with an independent ABSA Accredited Energy Assessor.

For material properties, refer Specification J1.2 Material Properties of BCA 2007.

CORPORATE MEMBERS

- Asurco Contracting ■ [08] 8240 0999
- Bianco Precast ■ [08] 8359 0666
- Delta Corporation ■ [08] 9296 5000 (WA) or [08] 8363 4817 (SA)
- Duggans Concrete ■ [03] 6266 3204
- Giroto Precast ■ [03] 9794 5185 (VIC) or [02] 9608 5100 (NSW) [07] 3265 1999 (QLD)
- Hanson Precast ■ [02] 9627 2666
- Hicrete Precast ■ [08] 8260 1577
- Hollow Core Concrete ■ [03] 9369 4944
- Humes Flooring ■ 1300 361601
- Paragon Precast Industries ■ [08] 9454 9300
- Precast Concrete Products ■ [07] 3271 2766
- Precast Solutions ■ [07] 3807 4511
- Precast WA ■ [08] 9332 6310
- Reinforced Earth ■ [02] 9910 9910
- Rocla Building Products ■ [02] 9928 3552
- SA Precast ■ [08] 8346 1771
- Sasso Precast Concrete ■ [02] 9604 9444
- Structural Concrete Industries ■ [02] 9411 7764
- The Precasters ■ [03] 6267 9261
- Ultrafloor (Aust) ■ [02] 4932 4433 or [03] 9614 1787
- Waeger Precast ■ [02] 4932 4900
- Westkon Precast Concrete ■ [03] 9312 3688

ASSOCIATE MEMBERS

- Actech International ■ [03] 9357 3366
- Barossa Quarries ■ [08] 8564 2227
- Baseline Constructions ■ [02] 9080 2222
- BASF Construction Chemicals Australia ■ [02] 8811 4200
- Blue Circle Southern Cement ■ [02] 9033 4000
- Cement Australia ■ [03] 9688 1943
- Coates Hire Propping ■ [02] 8723 6300
- CSR Topcat Safety Rail ■ [02] 9896 5250
- Grace Construction Products ■ [07] 3276 3809
- Hallweid Bennett ■ [08] 8347 0800
- Hilti (Aust) ■ 13 12 92
- LW Contracting ■ [02] 4735 6716
- Nawkaw Australia ■ 1300 629 529
- Nupol Composites ■ [02] 9666 0331
- OneSteel Reinforcing ■ [02] 8424 9802
- Reckli Australia & New Zealand ■ 0418 17 6044
- Reid Construction Systems ■ 1300 780 250
- RJB Industries ■ [03] 9794 0802
- Sika Aust ■ [02] 9725 1145
- Sunstate Cement ■ [07] 3895 1199
- Xypex Australia ■ [02] 6040 2444

PROFESSIONAL ASSOCIATE MEMBERS

- BDO Kendall ■ [02] 9286 5850
- Connell Wagner ■ [02] 9465 5751
- Moray & Agnew ■ [02] 4911 5400
- Robert Bird Group ■ [02] 8246 3200
- Strine Design ■ [02] 6282 4877

OVERSEAS MEMBERS

- Cem-FIL International ■ [66 2] 3660240
- Golik Precast Ltd (Hong Kong) ■ 852-2634 1818
- Halfen-Deha Pte Ltd ■ [03] 9727 7700

The information provided in this publication is of a general nature and should not be regarded as specific advice. Readers are cautioned to seek appropriate professional advice pertinent to the specific nature of their interest.

Published by
**National Precast Concrete
Association Australia**

1/184 Old Canterbury Rd
Summer Hill NSW 2130 Australia
PO Box 396 Summer Hill NSW 2130
Tel [02] 9799 3421 Fax [02] 9799 8423
Email: info@npcaa.com.au

Executive Officer – Sarah Moore

www.npcaa.com.au